

## Ficha técnica de familia de producto LINEARlight FLEX Tunable White

### – Accesorios para Flex



---

### BENEFICIOS DEL PRODUCTO

- Instalación sencilla, sin necesidad de herramientas o soldadura (CONNECTsystem)
- Tiempo de instalación reducido (CONNECTsystem)
- Perfil bajo
- Extremadamente resistente a las vibraciones (CONNECTsystem)
- Puede conectarse a la parte frontal del módulo o a los puntos de división (CONNECTsystem)

## DATOS TÉCNICOS

## Dimensiones y peso

Descripción del producto	Ancho	Alto	Largo
LF-LTS -2100	14,6 mm	9,2 mm	2100 mm
LF -CONN-10 FLEX	13,2 mm	5,3 mm	13,2 mm
LF-LTS -COVER-CLEAR	17,7 mm	5,3 mm	2100 mm
LF-LTS -COVER-DIFF	17,7 mm	24,0 mm	2100 mm
LF-LTS -COVER-SHORTPITCH	17,7 mm	10,5 mm	2100 mm
LF-LTS -ENDCAP	20,0 mm	8,0 mm	20,0 mm
LF-LTS -MB	16,0 mm	4,4 mm	35,0 mm
FX -SC08-G2--BTJ-IP54	15,7 mm	8,2 mm	30,0 mm
FX -SC08-G2-CT2PF-0500	9,2 mm	5,9 mm	510,0 mm
FX -SC08-G2-CT2PF-1000	9,2 mm	5,9 mm	1010 mm
FX -SC08-G2-CT3PF-0500HF	9,2 mm	4,8 mm	509,8 mm
FX -SC08-G2-CT3PFE-0500HF	9,2 mm	4,8 mm	509,8 mm
FX -SC08-G2--CT4PF-0500	9,2 mm	5,9 mm	510,0 mm
FX -SC08-G2--CT4PF-1000	9,2 mm	5,9 mm	1010 mm
FX -SC08-G2-CT4PJ	9,2 mm	5,9 mm	9,0 mm
FX -SC08-G1-FW4P-LIN-0300	4,0 mm	1,0 mm	300,0 mm
LF -WIRE-30 FLEX SC	8,0 mm		30,0 mm
LF -WIRE-150 FLEX SC	8,0 mm		150,0 mm

**Dibujo del producto**

---

LF-LTS -2100

---

LF -CONN-10 FLEX

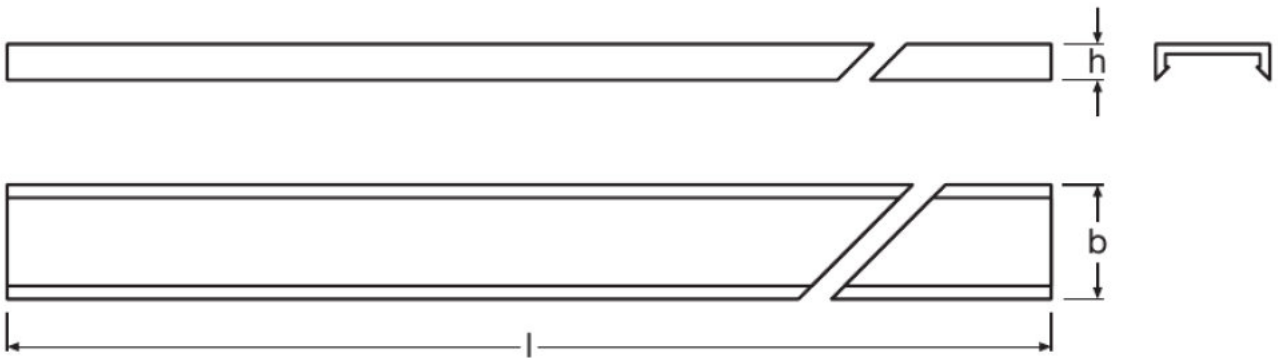

LF-LTS -COVER-CLEAR

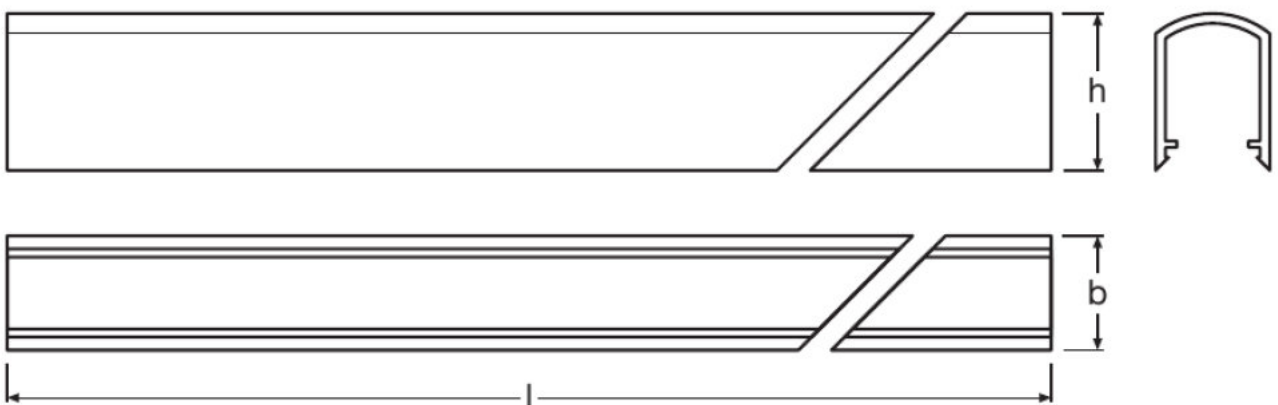

LF-LTS -COVER-DIFF

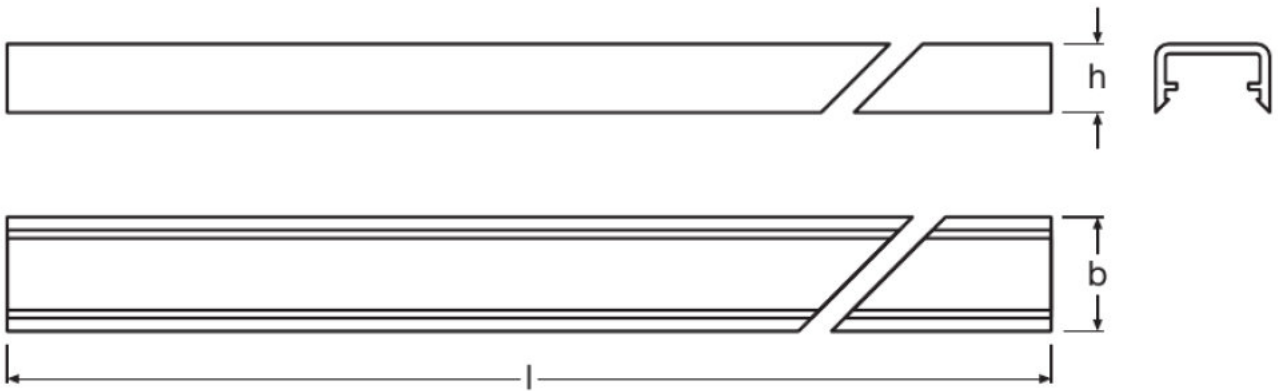

---

LF-LTS -COVER-SHORTPITCH

---

LF-LTS -ENDCAP

---

LF-LTS -MB

---

FX -SC08-G2--BTJ-IP54

---

FX -SC08-G2-CT2PF-0500

---

FX -SC08-G2-CT2PF-1000

---

FX -SC08-G2-CT3PF-0500HF, FX -SC08-G2-CT3PFE-0500HF

---

FX -SC08-G2--CT4PF-0500



---

FX -SC08-G2--CT4PF-1000

---

FX -SC08-G2-CT4PJ

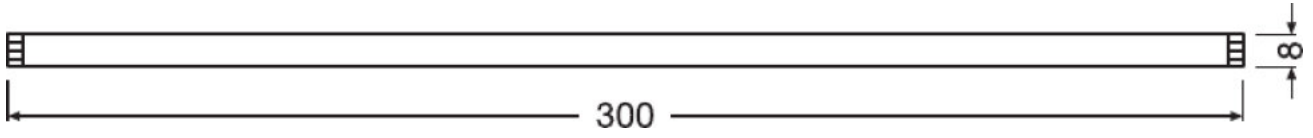

---

FX -SC08-G1-FW4P-LIN-0300

---

LF -WIRE-30 FLEX SC

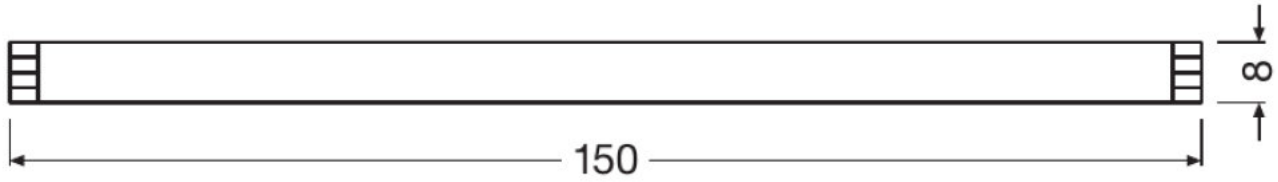

LF -WIRE-150 FLEX SC

### INSTRUCCIONES DE INSTALACIÓN

Para información detallada de aplicación y gráficos, por favor vea ficha técnica del producto.

### SOPORTE VENTAS Y TÉCNICO











Soporte ventas y técnico [www.ledvance.es](http://www.ledvance.es)

### INFORMACIÓN DEL PAÍS

Descripción del producto	Código del producto	METEL-Code	SEG-Nr.	Número STK	UK Org
LF-LTS -2100	4008321978981	-	7500257	4107786	-
LF -CONN-10 FLEX	4008321955333	OSRLFCOONN10F	7552452	4030053	-
LF-LTS -COVER-CLEAR	4008321790187	-	7500259	4107794	-
LF-LTS -COVER-DIFF	4008321979001	-	7500258	4107788	-
LF-LTS -COVER-SHORTPITCH	4008321790200	-	7500260	4107789	-
LF-LTS -ENDCAP	4052899387591	-	7503594	4107791	-
LF-LTS -MB	4008321979025	-	7500261	4107792	-
LF-LTS -MB	4008321790163	-	-	4107792	-
LF-LTS -MB	4052899381018	-	7503593	-	-
FX -SC08-G2-CT2PF-0500	4052899464735	-	-	4210408	-

FX -SC08-G2-CT2PF-0500	4052899464742	-	7503595	-	-
FX -SC08-G2-CT2PF-1000	4052899464773	-	7503596	-	-
FX -SC08-G2--CT4PF-0500	4052899464803	-	7503597	-	-
FX -SC08-G2--CT4PF-1000	4052899464834	-	7503598	-	-
FX -SC08-G2-CT4PJ	4052899464865	-	7503599	-	-
LF -WIRE-30 FLEX SC	4008321875587	-	7500547	4030220	-
LF -WIRE-150 FLEX SC	4008321875563	-	7500548	4030222	-

## DESCARGA DATOS

Fichero	
	Product Datasheet Specification Sheet Slim Track LF-LTS-2100
	Product Family Datasheet 349066_LINEARLIGHT FLEX SLIM TRACK SYSTEM - LF-LTS
	Folleto de ventas Light is freedom of design (EN)
	Eulumdat Eulumdat_LF LTS-2100_Clear
	Eulumdat Eulumdat_LF LTS-2100_Diffusive
	Eulumdat Eulumdat_LF LTS-2100_Opal
	Product Datasheet 335862_CONNECTsystem for LINEARlight Colormix Flex 8 mm LF4x-Flex (EN)
	Product Datasheet 726951_SLIMCONNECT SYSTEM 08 G2
	Product Datasheet Slimconnect system datasheet
	Product Family Datasheet 544831_SLIMCONNECTsystem FLEX Technical Datasheet

## DATOS LOGÍSTICOS

Código de producto	Cantidad por caja (unidad/master)	Dimensiones (longitud x largo x altura)	Peso bruto	Volúmen
4008321978998	Embalaje de envío 40	2105 mm x 60 mm x 100 mm	9530,00 g	12.63 dm <sup>3</sup>
4008321955487	Embalaje de envío 200	237 mm x 62 mm x 166 mm	2329,00 g	2.44 dm <sup>3</sup>
4008321790194	Embalaje de envío 40	2110 mm x 105 mm x 40 mm	6546,00 g	8.86 dm <sup>3</sup>

Código de producto	Cantidad por caja (unidad/master)	Dimensiones (longitud x largo x altura)	Peso bruto	Volúmen
4008321979018	Embalaje de envío 40	2110 mm x 160 mm x 80 mm	9824,00 g	27.01 dm <sup>3</sup>
4008321790217	Embalaje de envío 40	2110 mm x 105 mm x 60 mm	6634,00 g	13.29 dm <sup>3</sup>
4052899387607	Embalaje de envío 160	225 mm x 185 mm x 115 mm	336,00 g	4.79 dm <sup>3</sup>
4008321979032	Embalaje de envío 280	195 mm x 100 mm x 150 mm	1094,00 g	2.93 dm <sup>3</sup>
4052899381025	Embalaje de envío 280	195 mm x 100 mm x 150 mm	1194,00 g	2.93 dm <sup>3</sup>
4052899568877	Embalaje de envío 250	258 mm x 168 mm x 84 mm	1101,00 g	3.64 dm <sup>3</sup>
4052899464759	Embalaje de envío 280	510 mm x 340 mm x 315 mm	4146,00 g	54.62 dm <sup>3</sup>
4052899464780	Embalaje de envío 280	510 mm x 340 mm x 315 mm	6314,00 g	54.62 dm <sup>3</sup>
4052899483019	Embalaje de envío 280	510 mm x 340 mm x 315 mm	6202,00 g	54.62 dm <sup>3</sup>
4052899483040	Embalaje de envío 280	510 mm x 340 mm x 315 mm	6202,00 g	54.62 dm <sup>3</sup>
4052899464810	Embalaje de envío 280	510 mm x 340 mm x 315 mm	6202,00 g	54.62 dm <sup>3</sup>
4052899464841	Embalaje de envío 280	510 mm x 340 mm x 315 mm	9002,00 g	54.62 dm <sup>3</sup>
4052899464872	Embalaje de envío 1250	510 mm x 340 mm x 315 mm	6114,00 g	54.62 dm <sup>3</sup>
4052899469266	Embalaje de envío 15000	320 mm x 320 mm x 200 mm	13220,00 g	20.48 dm <sup>3</sup>
4008321875594	Embalaje de envío 10000	320 mm x 320 mm x 200 mm	8370,00 g	20.48 dm <sup>3</sup>
4008321875570	Embalaje de envío 5000	320 mm x 320 mm x 200 mm	5500,00 g	20.48 dm <sup>3</sup>

El código de producto mencionado describe la cantidad mínima de unidades que puede ser comprada. Una unidad de transporte puede contener uno o más productos individuales. Cuando se realiza la compra, para las cantidades por favor ingrese una o varias unidades de envío.

#### ACCESSORIES MANDATORY

Descripción del producto	Accessory name	Accessory code
LF-LTS -2100	LINEARlight FLEX Tunable White, -MB	▶ 4008321979032
LF-LTS -2100	LINEARlight FLEX Tunable White, -MB	▶ 4052899381025
LF-LTS -COVER-DIFF	LINEARlight FLEX Tunable White, -ENDCAP	▶ 4052899387607

#### ACCESSORIES OPTIONAL

Descripción del producto	Accessory name	Accessory code
LF-LTS -2100	LINEARlight FLEX Tunable White, -COVER-DIFF	▶ 4008321979018
LF-LTS -2100	LINEARlight FLEX ShortPitch, -COVER-SHORTPITCH	▶ 4008321790217
LF-LTS -2100	LINEARlight FLEX Tunable White, -COVER-CLEAR	▶ 4008321790194

---

**AVISO**

Sujeto a cambio sin aviso. Errores y omisiones exceptuadas. Asegurese de utilizar la version más reciente.